

1 2 3 4 5 6 7 8

A B C D E F

Vorne

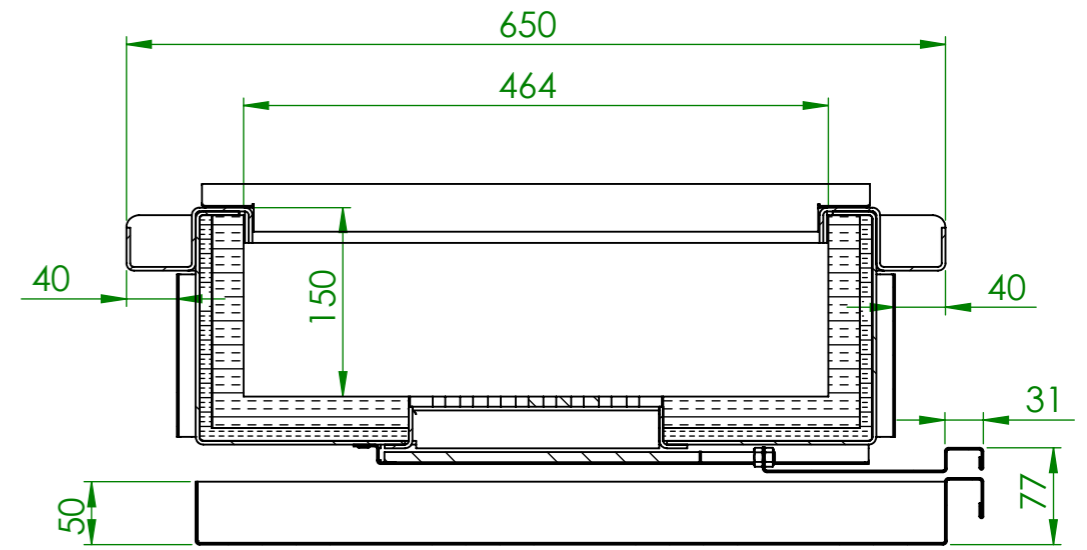
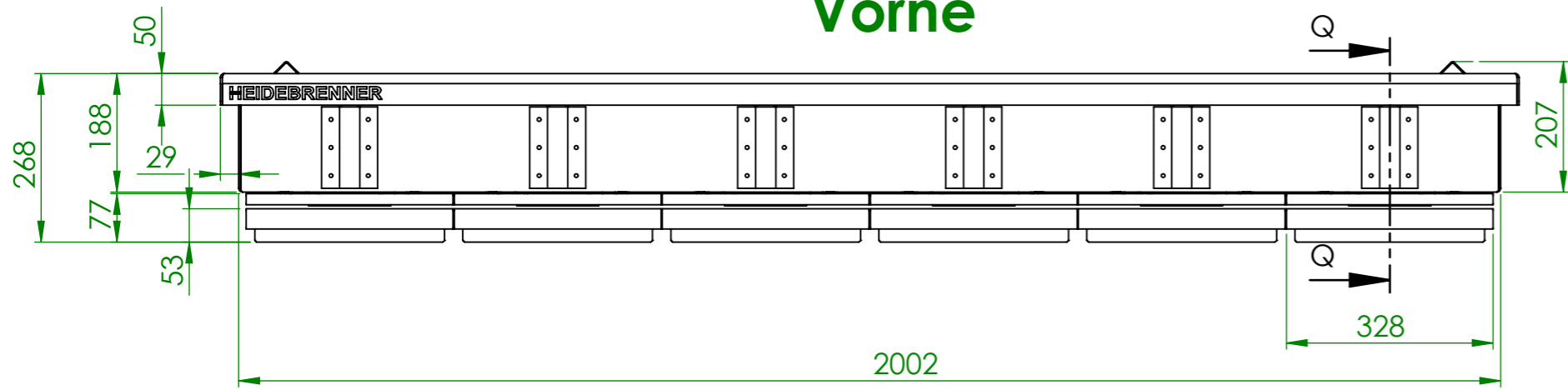

Q-Q
SCALE 1 : 6

Links

Oben

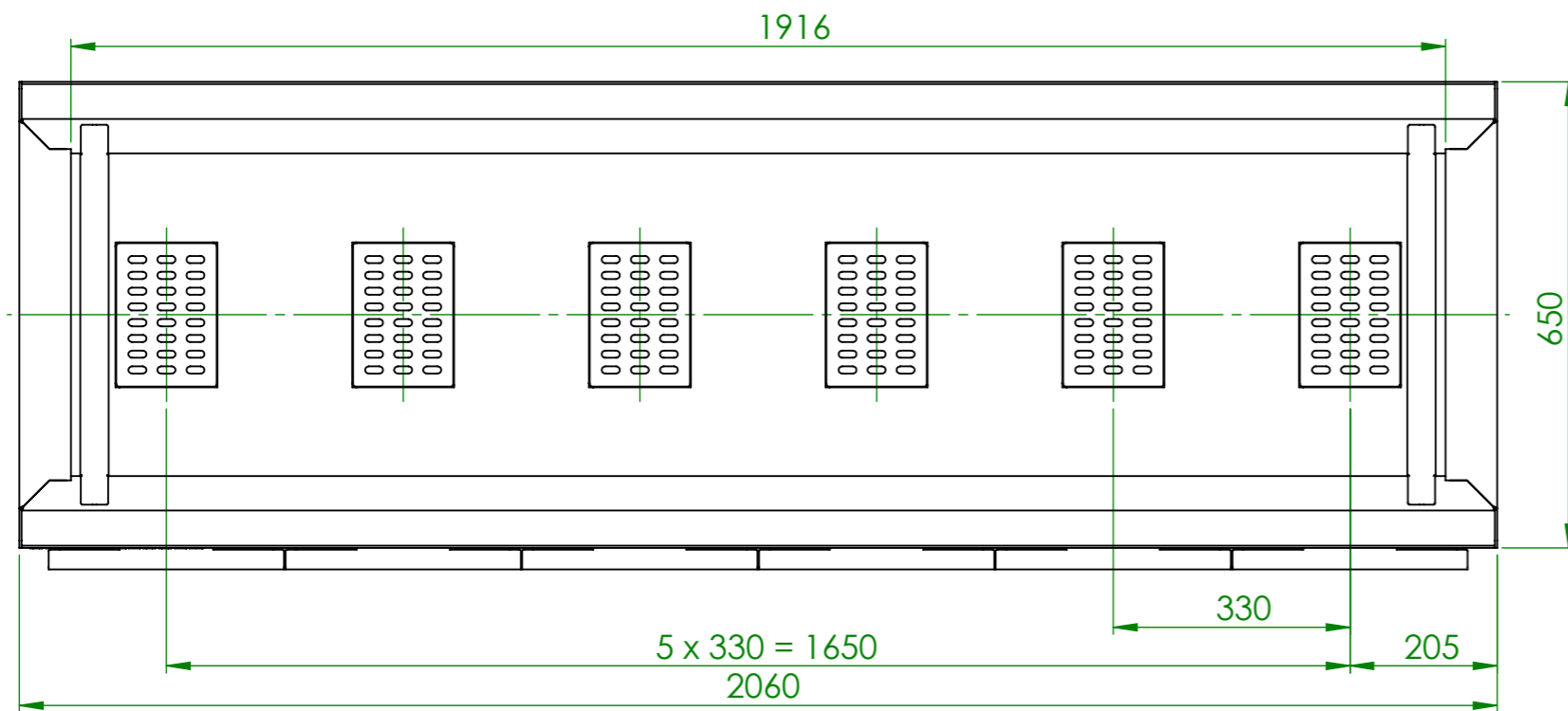

2 x Verschiebbare Spießauflage

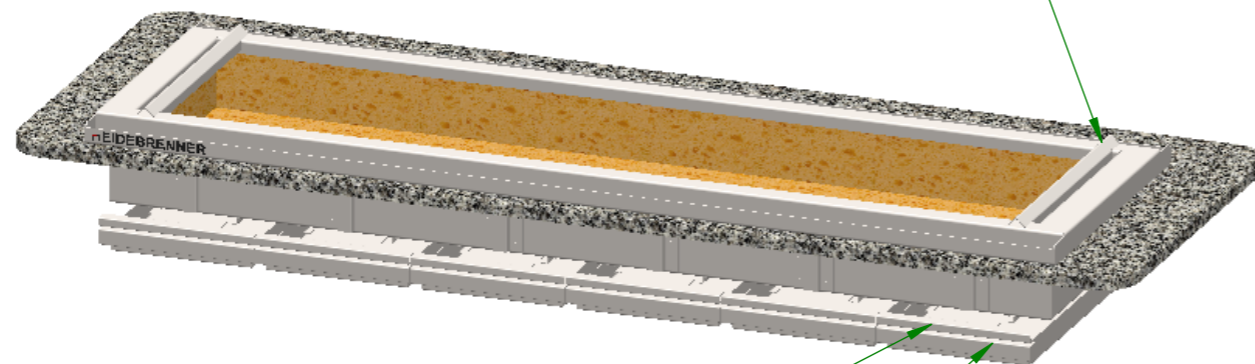

6 x Luftschieber

6 x Asche Schublade

Verwendungsbereich 2060x650x268	Toleranz nach DIN ISO 2768-mK	Oberflächen DIN ISO 1302	Maßstab: 1:5	Gewicht: 242kg
Bearb. M.G.		Datum 25.08.2021	Werkstoff 1.4301 AISI 304	
HEIDEBRENNER		Holzkohlen Grill - TEAK		A3
		HRCF - 650		

1 2 3 4

Vorne

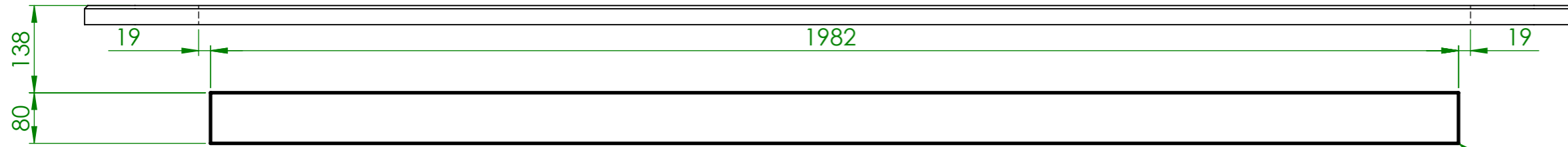

Ausschnittmassen

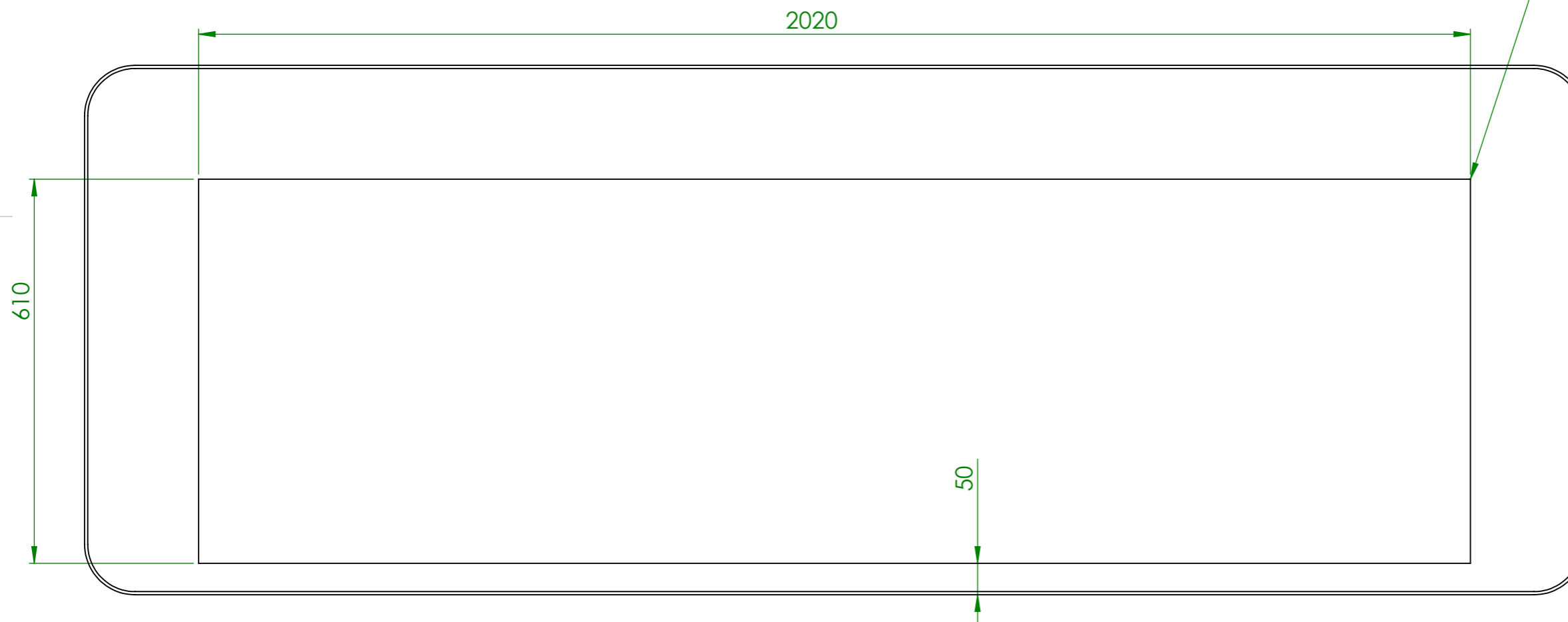

Oben

Verwendungsbereich 2060x650x268	Toleranz nach DIN ISO 2768-mK	Oberflächen DIN ISO 1302	Maßstab: 1:8	Gewicht: 242kg
			Werkstoff 1.4301 AISI 304	
Name	Datum	Holzkohlen Grill - TEAK		
Bearb. M.G.	25.08.2021			
HEIDEBRENNER		HRCF - 650		A3

Vorne

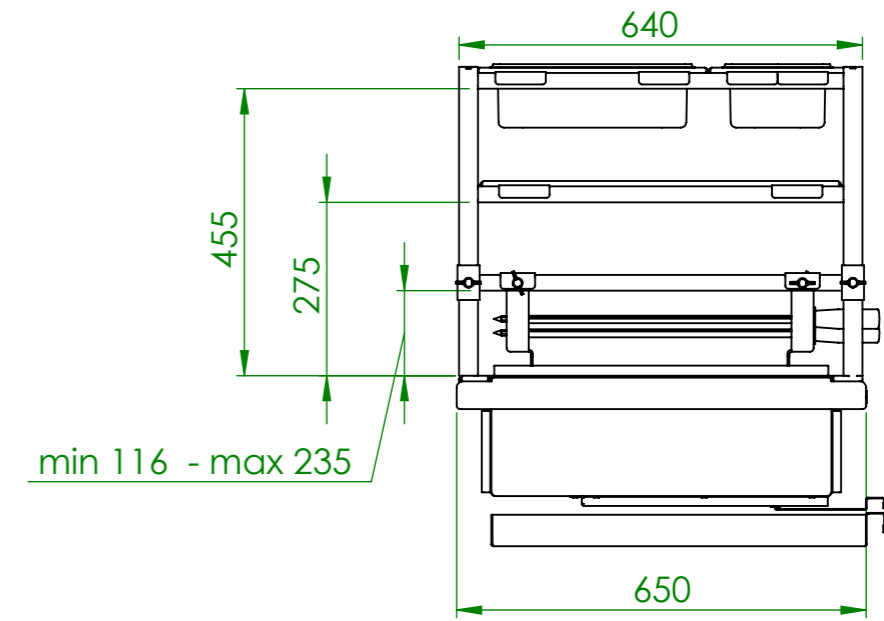
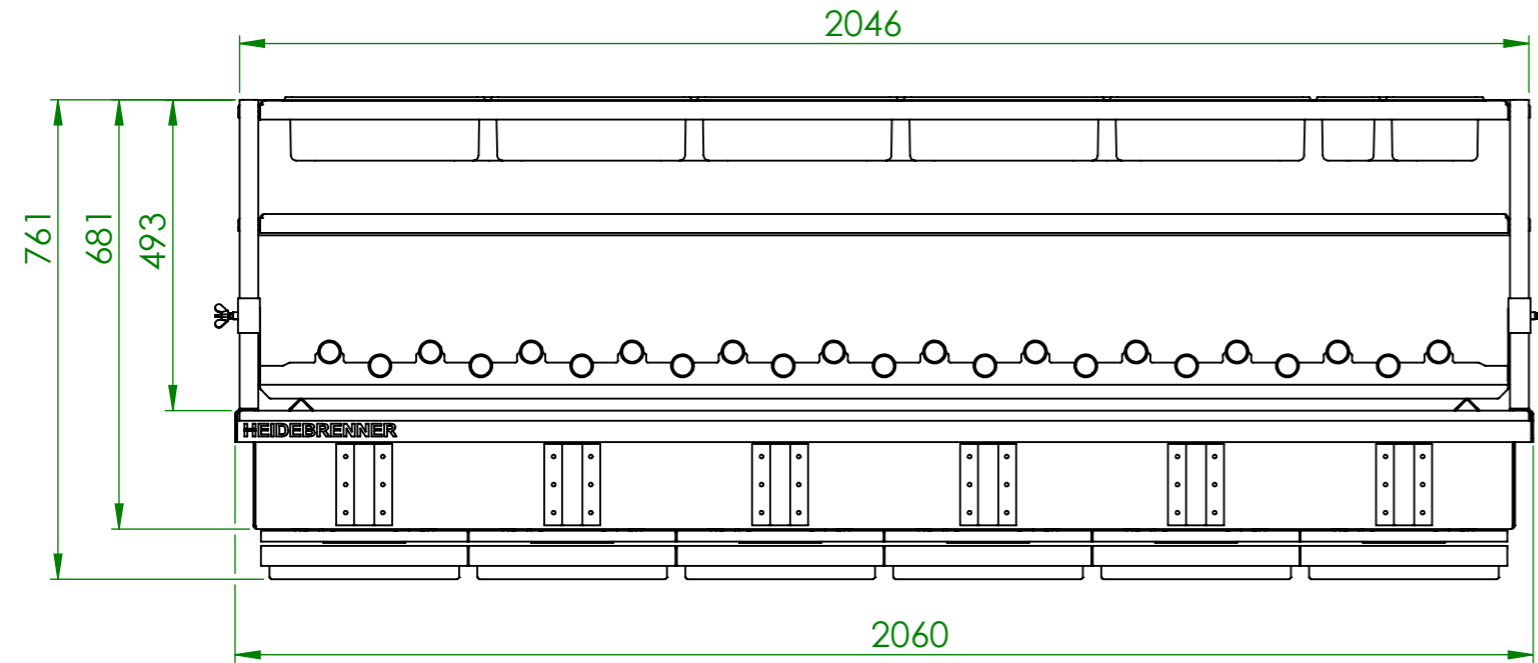

Links

Oben

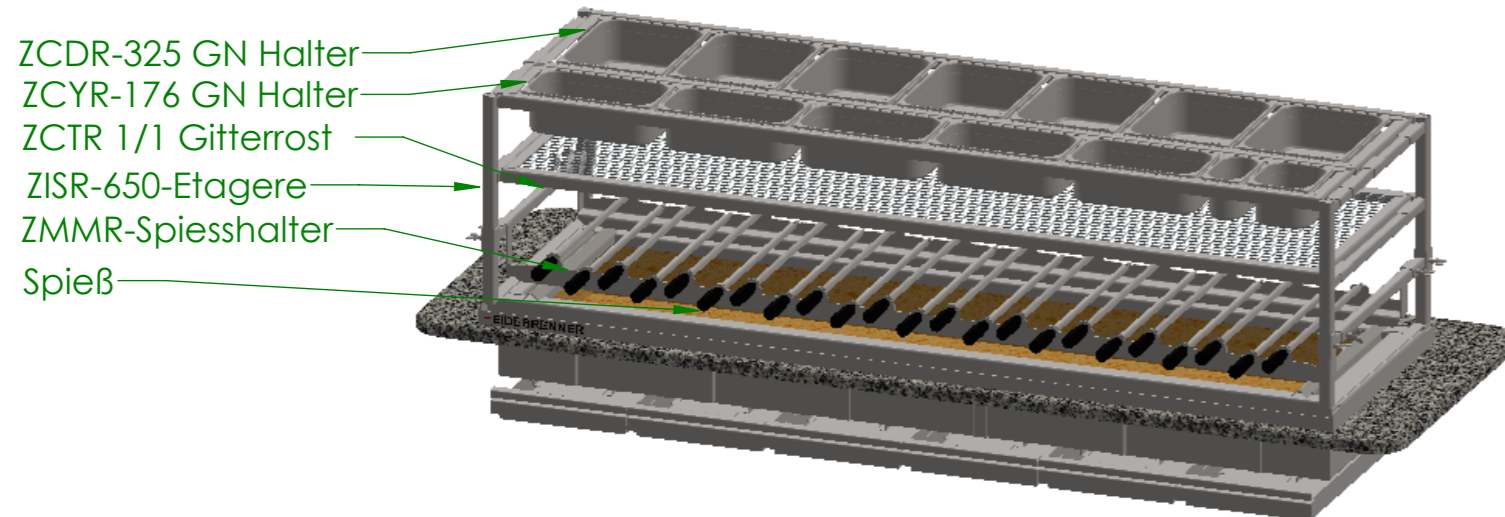
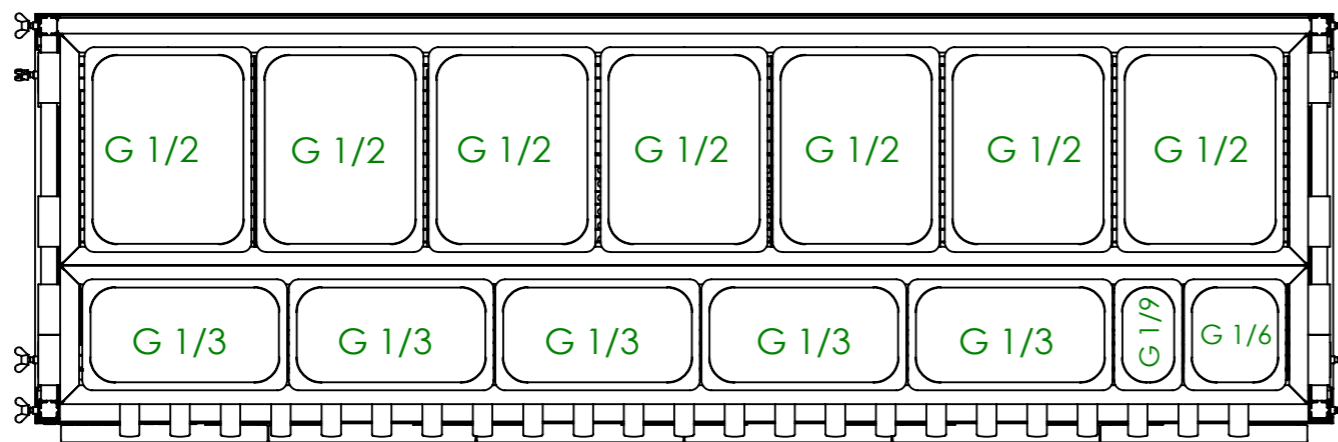

Verwendungsbereich 2060x650x761	Toleranz nach DIN ISO 2768-mK	Oberflächen DIN ISO 1302	Maßstab: 1:12	Gewicht: 314kg
		Werkstoff 1.4301 AISI 304		
Name	Datum	Holzkohlen Grill - TEAK + ETAGERE		
Bearb. M.G.	25.08.2021			
HEIDEBRENNER		HRCF-650 + ZISR-650		A3